

MGA-86576

1.5 – 8 GHz Low Noise GaAs MMIC Amplifier



Data Sheet

Description

Avago's MGA-86576 is an economical, easy-to-use GaAs MMIC amplifier that offers low noise and excellent gain for applications from 1.5 to 8 GHz.

The MGA-86576 may be used without impedance matching as a high performance 2 dB NF gain block. Alternatively, with the addition of a simple series inductor at the input, the device noise figure can be reduced to 1.6 dB at 4 GHz.

The circuit uses state-of-the-art PHEMT technology with self-biasing current sources, a source-follower interstage, resistive feedback, and on chip impedance matching networks.

A patented, on-chip active bias circuit allows operation from a single +5 V power supply. Current consumption is only 16 mA.

These devices are 100% RF tested to assure consistent performance.

Surface Mount Ceramic Package

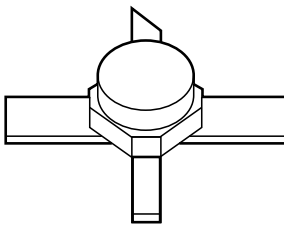

Pin Connections

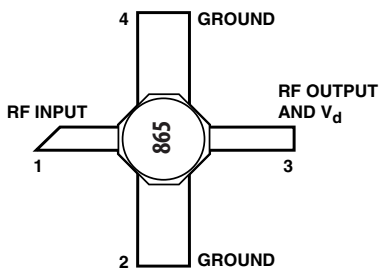

Features

- 1.6 dB Noise Figure at 4 GHz
- 23 dB Gain at 4 GHz
- +6 dBm P_{1dB} at 4 GHz
- Single +5 V Bias Supply

Applications

- LNA or Gain Stage for 2.4 GHz and 5.7 GHz ISM Bands
- Front End Amplifier for GPS Receivers
- LNA or Gain Stage for PCN and MMDS Applications
- C-Band Satellite Receivers
- Broadband Amplifier for Instrumentation

Schematic Diagram

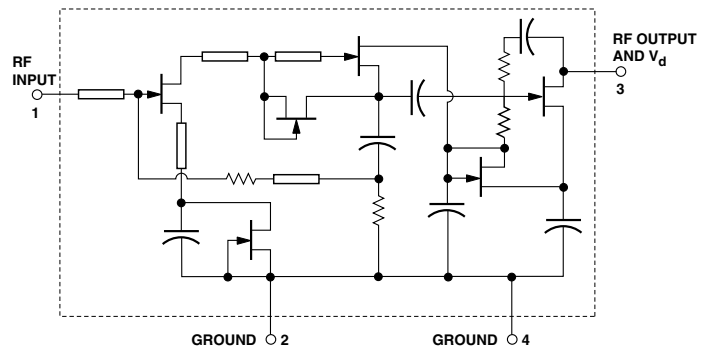

Attention: Observe precautions for handling electrostatic sensitive devices.
 ESD Machine Model (Class A)
 ESD Human Body Model (Class 0)
 Refer to Avago Application Note A004R:
Electrostatic Discharge Damage and Control.

Absolute Maximum Ratings

Symbol	Parameter	Units	Absolute Maximum ^[1]
V _d	Device Voltage, RF output to ground	V	9
V _g	Device Voltage, RF input to ground	V	+0.5 -1.0
P _{in}	CW RF Input Power	dBm	+13
T _{ch}	Channel Temperature	°C	150
T _{STG}	Storage Temperature	°C	-65 to 150

Thermal Resistance^[2]:

$$\theta_{ch-c} = 110^{\circ}\text{C/W}$$

Notes:

1. Operation of this device above any one of these limits may cause permanent damage.
2. T_c = 25°C (T_c is defined to be the temperature at the package pins where contact is made to the circuit board).

MGA-86576 Electrical Specifications, T_c = 25°C, Z₀ = 50 Ω, V_d = 5 V

Symbol	Parameters and Test Conditions	Units	Min.	Typ.	Max.
G _p	Power Gain (S ₂₁ ²)	f = 1.5 GHz f = 2.5 GHz f = 4.0 GHz f = 6.0 GHz f = 8.0 GHz	20	21.2 23.7 23.1 19.3 15.4	
NF ₅₀	50 Ω Noise Figure	f = 1.5 GHz f = 2.5 GHz f = 4.0 GHz f = 6.0 GHz f = 8.0 GHz		2.2 1.9 2.0 2.3 2.5	2.3
NF _o	Optimum Noise Figure (Input tuned for lowest noise figure)	f = 1.5 GHz f = 2.5 GHz f = 4.0 GHz f = 6.0 GHz f = 8.0 GHz		1.6 1.5 1.6 1.8 2.1	
P _{1dB}	Output Power at 1 dB Gain Compression	f = 1.5 GHz f = 2.5 GHz f = 4.0 GHz f = 6.0 GHz f = 8.0 GHz		6.4 7.0 6.3 4.3 3.8	
IP ₃	Third Order Intercept Point	f = 4.0 GHz		16.0	
VSWR	Input VSWR	f = 1.5 GHz f = 2.5 GHz f = 4.0 GHz f = 6.0 GHz f = 8.0 GHz		3.6:1 3.3:1 2.2:1 1.4:1 1.2:1	3.6:1
	Output VSWR	f = 1.5 GHz f = 2.5 GHz f = 4.0 GHz f = 6.0 GHz f = 8.0 GHz		2.5:1 2.1:1 1.7:1 1.4:1 1.3:1	
I _d	Device Current		9	16	22

MGA-86576 Typical Performance, $T_c = 25^\circ\text{C}$, $Z_0 = 50 \Omega$, $V_d = 5 \text{ V}$

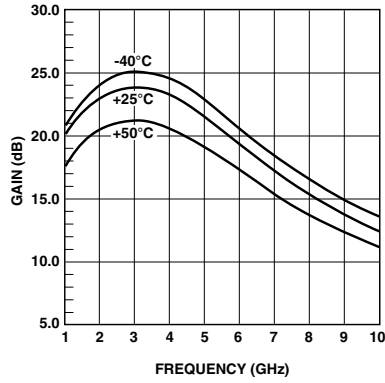

Figure 1. Power Gain vs. Frequency at Three Temperatures.

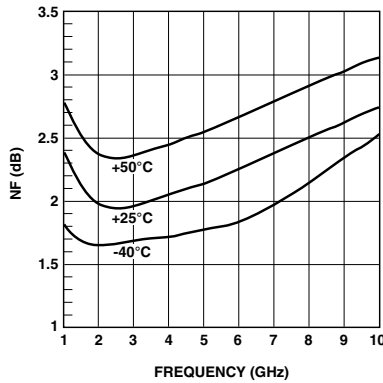

Figure 2. 50 Ω Noise Figure vs. Frequency at Three Temperatures.

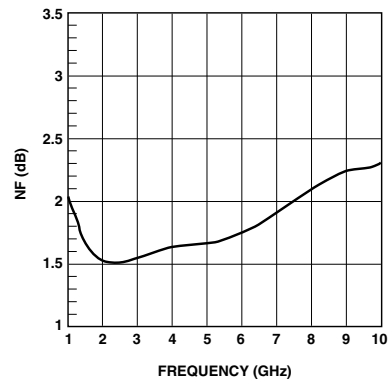

Figure 3. Matched Noise Figure vs. Frequency.

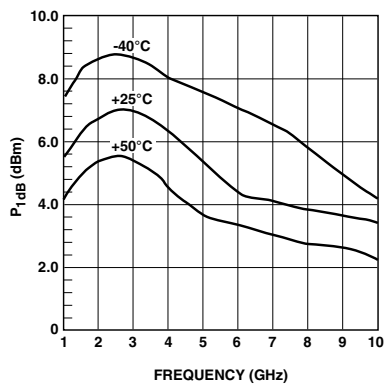

Figure 4. P_{1dB} vs. Frequency at Three Temperatures.

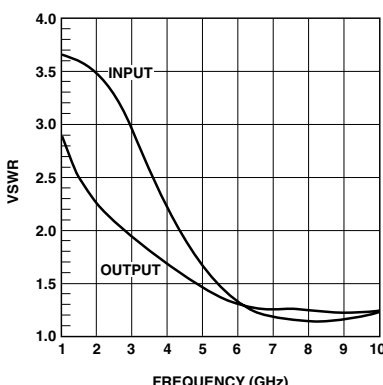

Figure 5. Input and Output VSWR vs. Frequency.

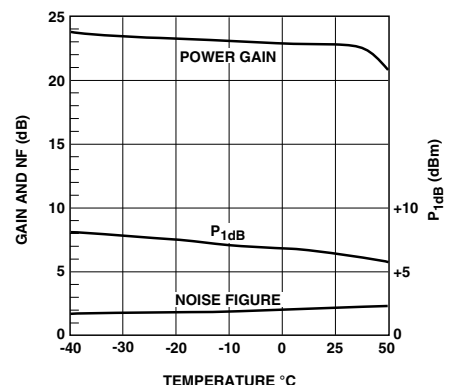

Figure 6. Gain, NF_{50} , and P_{1dB} vs. Temperature at 4 GHz.

MGA-86576 Typical Scattering Parameters^[3], $T_c = 25^\circ\text{C}$, $Z_0 = 50 \Omega$, $V_d = 5 \text{ V}$

Freq. GHz	S_{11}			S_{21}			S_{12}		S_{22}	
	Mag	Ang	dB	Mag	Ang	dB	Mag	Ang	Mag	Ang
0.5	0.57	-21	15.5	5.99	46	-46.5	0.005	-15	0.62	-35
1.0	0.55	-30	19.8	9.72	17	-51.3	0.003	11	0.49	-47
1.5	0.54	-44	21.7	12.15	-7	-51.2	0.003	58	0.43	-57
2.0	0.52	-59	22.8	13.84	-31	-47.0	0.004	85	0.39	-68
2.5	0.48	-77	23.5	14.98	-54	-43.0	0.007	96	0.36	-79
3.0	0.43	-96	23.8	15.56	-77	-39.7	0.010	100	0.33	-92
3.5	0.37	-116	23.7	15.28	-100	-37.0	0.014	99	0.29	-105
4.0	0.30	-137	23.2	14.49	-122	-35.0	0.018	95	0.25	-118
4.5	0.24	-159	22.4	13.18	-142	-33.2	0.022	92	0.21	-130
5.0	0.19	178	21.5	11.82	-160	-31.9	0.026	89	0.19	-139
5.5	0.14	151	20.5	10.54	-177	-30.6	0.030	85	0.14	-151
6.0	0.12	129	19.2	9.14	166	-29.6	0.033	81	0.17	-151
6.5	0.10	111	18.1	8.08	156	-28.7	0.037	82	0.14	-116
7.0	0.08	91	17.5	7.48	142	-27.4	0.042	76	0.08	-158
7.5	0.08	75	16.4	6.64	129	-26.6	0.047	72	0.11	-153
8.0	0.07	64	15.5	5.99	118	-25.8	0.051	69	0.09	-151
8.5	0.06	48	14.7	5.45	107	-25.0	0.056	65	0.09	-146
9.0	0.04	31	14.0	5.03	96	-24.2	0.062	62	0.09	-140
9.5	0.02	18	13.4	4.66	86	-23.4	0.068	58	0.11	-143
10.0	0.01	93	12.7	4.33	76	-22.6	0.074	53	0.11	-154

MGA-86576 Typical Noise Parameters^[3],

$T_c = 25^\circ\text{C}$, $Z_0 = 50\ \Omega$, $V_d = 5\ \text{V}$

Frequency GHz	NF_0 dB	Γ_{opt}		$R_N/50\ \Omega$
		Mag.	Ang.	
1.0	2.1	0.56	27	0.43
1.5	1.6	0.54	31	0.40
2.5	1.5	0.47	40	0.36
4.0	1.6	0.38	54	0.32
6.0	1.8	0.28	77	0.28
8.0	2.1	0.22	107	0.25

^[3]Reference plane taken at point where leads meet body of package.

MGA-86576 Applications Information

Introduction

The MGA-86576 is a high gain, broad band, low noise amplifier. The use of plated through holes or an equivalent minimal inductance grounding technique placed precisely under each ground lead at the device is highly recommended. A minimum of two plated through holes under each ground lead is preferred with four being highly suggested. A long ground path to pins 2 and 4 will add additional inductance which can cause gain peaking in the 2 to 4 GHz frequency range. This can also be accompanied by a decrease in stability. A suggested layout is shown in Figure 7. The circuit is designed for use on 0.031 inch thick FR-4/G-10 epoxy glass dielectric material.

Printed circuit board thickness is also a major consideration. Thicker printed circuit boards dictate longer plated through holes which provide greater undesired inductance. The parasitic inductance associated with a pair of plated through holes passing through 0.031 inch thick printed circuit board is approximately 0.1 nH, while the inductance of a pair of plated through holes passing through 0.062 inch thick board is about 0.2 nH. Avago does not recommend using the MGA-86576 MMIC on boards thicker than 0.040 inch.

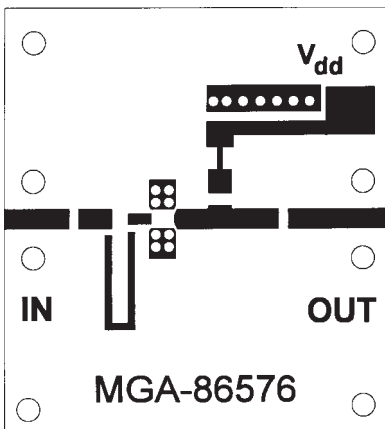

Figure 7. Layout for MGA-86576 Demonstration Amplifier. PCB dimensions are 1.18 inches wide by 1.30 inches high.

The effects of inductance associated with the board material are easily analyzed and very predictable. As a minimum, the circuit simulation should consist of the data sheet S-Parameters and an additional circuit file describing the plated through holes and any additional inductance associated with lead length between the device and the start of the plated through hole. To obtain a complete analysis of the entire amplifier circuit, the effects of the input and output microstrips and bias decoupling circuits should be incorporated into the circuit file.

Device Connections V_d and RF Output (Pin 3)

RF and DC connections are shown in Figure 8. DC power is provided to the MMIC through the same pin used to obtain RF output. A 50 Ω microstrip line is used to connect the device to the following stage or output connector. A bias decoupling network is used to feed in V_{dd} while simultaneously providing a DC block to the RF signal. The bias decoupling network shown in Figure 8, consisting of resistor R1, a short length of high impedance microstrip line, and bypass capacitor C1, provides the best overall performance in the 2 to 8 GHz frequency range.

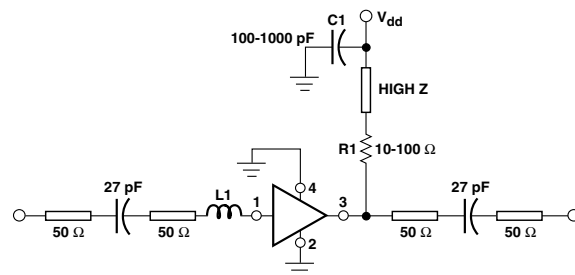

Figure 8. Demonstration Amplifier Schematic.

The use of lumped inductors is not desired since they tend to radiate and cause undesired feedback. Moving the bypass capacitor, C1, down the microstripline towards the V_{dd} terminal, as shown in Figure 9, will improve the gain below 2 GHz by trading off some high end gain. A minimum value of $10\ \Omega$ for R1 is recommended to de-Q the bias decoupling network, although $100\ \Omega$ will provide the highest circuit gain over the entire 1.5 to 8 GHz frequency range. V_{dd} will have to be increased accordingly for higher values of R1. For operation in the 2 to 6 GHz frequency range, a 10 pF capacitor may be used for DC blocking on the output microstripline. A larger value such as 27 pF is more appropriate for operation at 1.5 GHz.

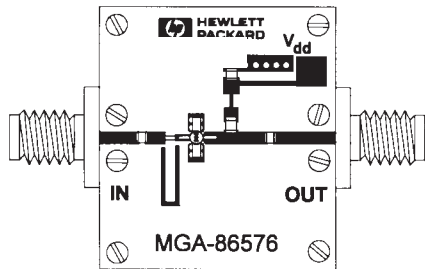

Figure 9. Complete MGA-86576 Demonstration Amplifier.

Ground (Pins 2 and 4)

Ground pins should attach directly to the backside ground plane by the shortest distance possible using the design hints suggested in the earlier section. Liberal use of plated through vias is recommended.

RF Input (Pin 1)

A $50\ \Omega$ microstripline can be used to feed RF to the device. A blocking capacitor in the 10 pF range will provide a suitable DC block in the 2 to 6 GHz frequency range. Although there is no voltage present at pin 1, it is highly suggested that a DC blocking capacitor be used to prevent accidental application of a voltage from a previous amplifier stage. With no further input matching, the MGA-86576 is capable of noise figures as low as 2 dB in the 2 to 6 GHz frequency range. Since Γ_o is not $50\ \Omega$, it is possible to design and implement a very simple matching network in order to improve noise figure and input return loss over a narrow frequency range. The circuit board layout shown in Figure 7 provides an option for tuning for a low noise match anywhere in the 1.5 to 4 GHz frequency range. For optimum noise figure performance in the 4 GHz frequency range, L1 can be a 0.007 inch diameter wire 0.080 inches in length as shown in Figure 9. Alternatively, L1 can be replaced by a 0.020 inch wide microstripline whose length can be adjusted for minimum noise figure in the 1.5 to 4 GHz frequency range.

Table 1 provides the approximate inductor length for minimum noise figure at a given frequency for the circuit board shown in Figure 7.

Table 1. L1 Length vs. Frequency for Optimum Noise Figure.

Frequency GHz	Length Inches
1.5	0.70
1.8	0.60
2.1	0.50
2.4	0.40
2.5	0.30
3.0	0.20
3.7	0.10
4.0	0.05

7 Volt Bias for Operation at Higher Temperatures

The MGA-86576 was designed primarily for 5 volt operation over the -25 to $+50^\circ\text{C}$ temperature range. For applications requiring use to $+85^\circ\text{C}$, a 7 volt bias supply is recommended to minimize changes in gain and noise figure at elevated temperature. Figure 10 shows typical gain, noise figure, and output power performance over temperature at 4 GHz with 7 volts applied. With a 7 volt bias supply, output power is increased approximately 1.5 dB. Other parameters are relatively unchanged from 5 volt data. S-parameter and noise parameter data for 7 volts are available upon request from Avago.

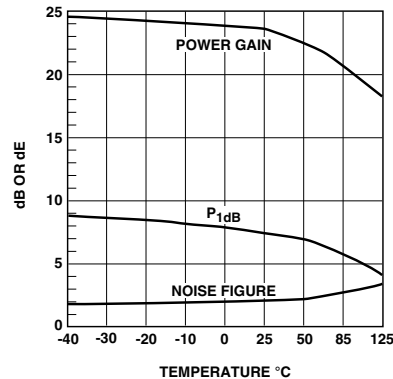

Figure 10. Gain, NF_{50} , and P_{1dB} vs. Temperature at 4 GHz with 7 Volt Bias Supply.

Printed Circuit Board Materials

Most commercial applications dictate the need to use inexpensive epoxy glass materials such as FR-4 or G-10. Unfortunately the losses of this type of material can become excessive above 2 GHz. As an example, a 0.5 inch long 50 Ω microstripline etched on FR-4 along with a blocking capacitor has a measured loss of 0.35 dB at 4 GHz. The 0.35 dB loss adds directly to the noise figure of the MGA-86576. The use of a low loss PTFE based dielectric material will preserve the inherent low noise of the MGA-86576.

Part Number Ordering Information

Part Number	No. of Devices	Container
MGA-86576-TR1	1000	7" Reel
MGA-86576-STRG	100	Strips

Package Dimensions

76 Package

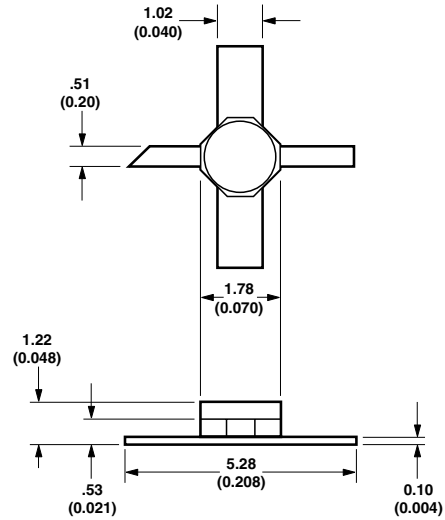

TYPICAL DIMENSIONS ARE IN MILLIMETERS (INCHES).

For product information and a complete list of distributors, please go to our web site: www.avagotech.com

vago, Avago Technologies, and the A Logo are trademarks of Avago Technologies Limited in the United States and other countries. Data subject to change. Copyright © 2005-2008 Avago Technologies Limited. All rights reserved. Obsoletes 5989-4658EN AV02-0608EN - April 29, 2008

AVAGO
TECHNOLOGIES